

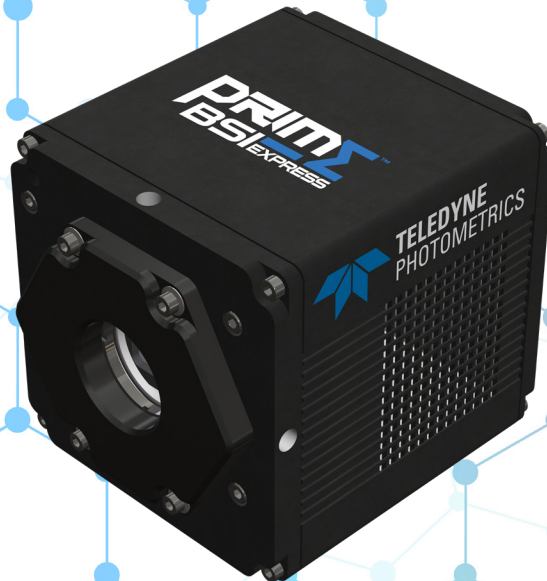

TELEDYNE PHOTOMETRICS
Everywhere **you** look™



PRIME™
BSI EXPRESS

Prime BSI Express Manual



© Copyright 2019 Teledyne Photometrics
3440 East Britannia Drive
Tucson, Arizona 85706
Tel: +1 520.889.9933
Fax: +1 520.295.0299

All rights reserved. No part of this publication may be reproduced by any means without the written permission of Teledyne Photometrics.

Acrobat and Reader are registered trademarks of Adobe Systems Incorporated in the United States and/or other countries.

Teledyne Photometrics and PVCAM are registered trademarks of Teledyne Technologies.

Prime, Prime BSI and Prime BSI Express are trademarks of Teledyne Photometrics.

Intel Core is a trademark of Intel Corporation in the U.S. and/or other countries.

Windows is a registered trademark of Microsoft Corporation in the United States and/or other countries.

All other brand and product names are the trademarks of their respective owners and manufacturers.

The information in this publication is believed to be accurate as of the publication release date. However, Teledyne Photometrics does not assume any responsibility for any consequences including any damages resulting from the use thereof. The information contained herein is subject to change without notice. Revision of this publication may be issued to incorporate such change.

LIMITED WARRANTY

Teledyne Photometrics ("Teledyne Photometrics," us," "we," "our") makes the following limited warranties. These limited warranties extend to the original purchaser ("You", "you") only and no other purchaser or transferee. We have complete control over all warranties and may alter or terminate any or all warranties at any time we deem necessary.

Basic Limited Two (2) Year Warranty

Teledyne Photometrics warrants this product against substantial defects in materials and/or workmanship for a period of up to two (2) years after shipment. During this period, Teledyne Photometrics will repair the product or, at its sole option, repair or replace any defective part without charge to you. You must deliver the entire product to the Teledyne Photometrics factory or, at our option, to a factory-authorized service center. You are responsible for the shipping costs to return the product. International customers should contact their local Teledyne Photometrics-authorized representative/distributor for repair information and assistance or visit our technical support page at www.photometrics.com.

Limited One (1) Year Warranty on Refurbished or Discontinued Products

Teledyne Photometrics warrants, with the exception of the CMOS or CCD image sensor device (which carries NO WARRANTIES EXPRESS OR IMPLIED), this product against defects in materials or workmanship for a period of up to one (1) year after shipment. During this period, Teledyne Photometrics will repair or replace, at its sole option, any defective parts, without charge to you. You must deliver the entire product to the Teledyne Photometrics factory or, at our option, a factory-authorized service center. You are responsible for the shipping costs to return the product to Teledyne Photometrics. International customers should contact their local Teledyne Photometrics representative/distributor for repair information and assistance or visit our technical support page at www.photometrics.com.

Normal Wear Item Disclaimer

Teledyne Photometrics does not warrant certain items against defect due to normal wear and tear. These items include internal and external shutters, cables, and connectors. *These items carry no warranty, expressed or implied.*

Software Limited Warranty

Teledyne Photometrics warrants all of our manufactured software discs or memory devices to be free from substantial defects in materials and/or workmanship under normal use for a period of one (1) year from shipment.

Teledyne Photometrics does not warrant that the function of the software will meet your requirements or that operation will be uninterrupted or error free. You assume responsibility for selecting the software to achieve your intended results and for the use and results obtained from the software. In addition, during the one (1) year limited warranty, the original purchaser is entitled to receive free version upgrades. Version upgrades supplied free of charge will be in the form of a download from the Internet. Those customers who do not have access to the Internet may obtain the version upgrades on a USB memory device from our factory for an incidental shipping and handling charge.

Owner's Manual and Troubleshooting

You should read the owner's manual thoroughly before operating this product. In the unlikely event that you should encounter difficulty operating this product, refer to the owner's manual. If the problem persists, please contact the Teledyne Photometrics technical support staff or an authorized service representative.

Your Responsibility

The above Limited Warranties are subject to the following terms and conditions:

You must retain your bill of sale (invoice) and present it upon request for service and repairs or provide other proof of purchase satisfactory to Teledyne Photometrics.

You must notify the Teledyne Photometrics factory service center within thirty (30) days after you have taken delivery of a product or part that you believe to be defective. With the exception of customers who claim a "technical issue" with the operation of the product or part, all invoices must be paid in full in accordance with the terms of sale. Failure to pay invoices when due may result in the interruption and/or cancellation of your two (2) year limited warranty and/ or any other warranty, expressed or implied.

All warranty service must be made by the Teledyne Photometrics factory or, at our option, an authorized service center. Before products or parts can be returned for service you must contact the Teledyne Photometrics factory and receive a return authorization number (RMA). Products or parts returned for service without a return authorization evidenced by an RMA will be sent back freight collect.

These warranties are effective only if purchased from the Teledyne Photometrics factory or one of our authorized manufacturer's representatives or distributors.

Unless specified in the original purchase agreement, Teledyne Photometrics is not responsible for installation, setup, or disassembly at the customer's location.

Warranties extend only to defects in materials or workmanship as limited above and do not extend to any product or part which has:

- been lost or discarded by you;
- been damaged as a result of misuse, improper installation, faulty or inadequate maintenance, or failure to follow instructions furnished by us;
- had serial numbers removed, altered, defaced, or rendered illegible;
- been subjected to improper or unauthorized repair; or
- been damaged due to fire, flood, radiation, or other "acts of God" or other contingencies beyond the control of Teledyne Photometrics.

After the warranty period has expired, you may contact the Teledyne Photometrics factory or a Teledyne Photometrics-authorized representative for repair information and/or extended warranty plans.

Physically damaged units or units that have been modified are not acceptable for repair in or out of warranty and will be returned as received.

All warranties implied by state law or non-U.S. laws, including the implied warranties of merchantability and fitness for a particular purpose, are expressly limited to the duration of the limited warranties set forth above. With the exception of any warranties implied by state law or non-U.S. laws, as hereby limited, the forgoing warranty is exclusive and in lieu of all other warranties, guarantees, agreements, and similar obligations of manufacturer or seller with respect to the repair or replacement of any parts. In no event shall Teledyne Photometrics' liability exceed the cost of the repair or replacement of the defective product or part.

This limited warranty gives you specific legal rights and you may also have other rights that may vary from state to state and from country to country. Some states and countries do not allow limitations on how long an implied warranty lasts, when an action may be brought, or the exclusion or limitation of incidental or consequential damages, so the above provisions may not apply to you.

When contacting us for technical support or service assistance, please refer to the Teledyne Photometrics factory of purchase, contact your authorized Teledyne Photometrics representative or reseller, or visit our technical support page at www.photometrics.com.

U. S. Government Restricted Rights

The software and documentation are provided with Restricted Rights. Use, duplication, or disclosure by the Government is subject to restrictions as set forth in subparagraph (c)(1)(ii) of the Rights in Technical Data and Computer Software clause at DFARS 252.227-7013 or subparagraphs (c)(1) and (2) of the Commercial Computer Software-Restricted Rights at 48 CFR 52.227-19, as applicable. Contractor/manufacturer is Teledyne Photometrics, 3440 East Britannia Drive, Tucson, AZ 85706.

This license is effective until terminated. It will terminate upon the conditions set forth above or if you fail to comply with any term hereof. Upon termination, you agree that the software and accompanying materials, and all copies thereof, will be destroyed. This agreement is governed by the laws of the State of Arizona. You acknowledge that you have read this agreement, you understand it, you agree to be bound by its terms, and that this is the complete and exclusive statement of the agreement between you and Teledyne Photometrics regarding the software.

Table of Contents

Chapter 1 - Overview	1
About This Manual.....	1
Precautions.....	1
Environmental Requirement.....	2
Storage Requirements.....	2
Microscopes, Lenses, and Tripods.....	2
Repairs.....	2
Cleaning.....	2
Chapter 2 - System Installation	3
Introduction.....	3
Getting to Know Prime BSI Express.....	4
Software Compatibility Requirements.....	4
Host Computer Requirements.....	5
Software Installation.....	5
Installing the PCI Express Interface Card.....	5
Connecting Prime BSI Express with USB 3.2.....	8
Chapter 3 - Theory of Operation	9
Introduction.....	9
CMOS Image Sensor Structure.....	9
Gain Combining and Bit-Depth.....	10
Rolling and Global Shutter Readout.....	11
Digital Binning.....	12
Sensor Clearing.....	12
Bias Offset.....	12
Pixel Noise Filters.....	13
Signal Processing.....	14
Chapter 4 - Operating Features	15
Introduction.....	15
Gain States.....	15
Bias Offset Setting.....	15

Clearing Mode Selection	16
Single Regions of Interest.....	16
Programmable Scan Mode.....	16
Device Synchronization (Triggering).....	18
Trigger Modes	18
Timed Mode (Internal).....	18
Trigger-First Mode.....	19
Edge Mode.....	19
Expose Out Modes.....	19
First Row.....	19
Any Row.....	20
Rolling Shutter Mode.....	20
Multiple Output Triggers.....	21
SMART Streaming	22
Fan Speed Control and Liquid Cooling.....	22
Time Stamps.....	23
Chapter 5 - Troubleshooting.....	24
System Does Not Boot Normally.....	24
New Hardware Found Dialog Box Does Not Appear.....	24
Images Not Displayed.....	25
Camera Running Too Warm.....	25
PVCAM Error Message Appears.....	25
Lengthy Pauses During Imaging.....	25
Chapter 6 - Basic Specifications.....	26
Prime BSI Express Front, Side, Rear Views.....	26
Camera Weight.....	26
Power Supply Specifications.....	26

Chapter 1 - Overview

About This Manual

This Prime BSI Express Scientific CMOS Camera User Manual is divided into five chapters. Teledyne Photometrics recommends you read this entire manual before operating the camera to ensure proper use. The chapter contents are briefly described below.

Note: The information in these chapters applies only to the Prime BSI Express camera and is currently not applicable to any other Teledyne Photometrics camera.

- **System Installation** – Instructions for connecting the Prime BSI Express camera to a computer via the USB 3.2 Gen 2 interface.
- **Theory of Operation** – A basic overview of Scientific CMOS camera technology as used in the Prime BSI Express camera.
- **Operating Features** – Prime BSI Express features and how to optimize them for speed and sensitivity, and how to use the different trigger modes.
- **Troubleshooting** – Answers to common camera system questions.
- **Basic Specifications** – Specifications for Prime BSI Express system components.

Precautions

The CMOS sensor and other system electronics are extremely sensitive to electrostatic discharge (ESD). To avoid permanently damaging the system, please observe the following precautions:

- If using high-voltage equipment (such as an arc lamp) with the camera system, turn the camera power on last and when powering down, power the camera off first.
- Never connect or disconnect any cable while the system is powered on.
- The camera's power should be switched off before disconnecting any camera system cables. However it is not necessary to power off the computer to detach the cables.
- Use caution when triggering high-current switching devices (such as an arc lamp) near the system. The image sensor can be permanently damaged by transient voltage spikes. If electrically noisy devices are present, an isolated, conditioned power line or dedicated isolation transformer is highly recommended.
- Always leave one inch of space around the camera for airflow.
- Do not operate the camera without cooling.
- Never open the camera. There are no user-serviceable parts inside the Prime BSI Express camera. Opening the camera voids the warranty.
- Use only the interface card, cables and power supply designated for this camera system. Using non-Prime BSI Express cables, interface cards or power supplies may result in unexpected errors or permanent damage to the system.
- Do not use a C-mount lens with optics that extend behind the lens flange.

Environmental Requirements

The Prime BSI Express camera system should be operated in a clean, dry environment. The camera system's ambient operating temperature is 0°C to 30°C with 80% relative humidity, non-condensing.

Storage Requirements

Store the Prime BSI Express camera system in its original containers. To protect the system from excessive heat, cold and moisture, store at an ambient temperature between -20°C and 60°C with a relative humidity of 0% to 90%, noncondensing.

Microscopes, Lenses, and Tripods

The camera has a standard threaded video mount and can be mounted to any microscope that accepts a standard C-mount adapter. The camera also allows you to install any lens that is compatible with a standard threaded video mount as long as its optics do not extend behind the flange of the lens. The Prime BSI Express can be mounted to optical tables, tripods and copy stands using the eight ¼-20 threaded attachment points located near the camera front and rear on all sides (see figure 1)

Repairs

Please save the original packing materials so you can safely ship the camera to another location or return it for repairs if necessary. The Prime BSI Express camera system contains no user-serviceable parts. Repairs must be done by Teledyne Photometrics. Should the camera system require repairs, please contact Teledyne Photometrics Customer Service.

Note: Do not open the camera. Opening the Prime BSI Express camera voids the warranty.

Cleaning

Clean exterior surfaces of the camera with a dry, lint-free cloth. To remove stains, contact Teledyne Photometrics Customer Service. To clean the camera's imaging window, use only a filtered compressed-air source. Hand-held cans are not recommended as they may spray propellant onto the window. Do not touch the window.

Chapter 2 – System Installation

Carefully review the Precautions section in the previous chapter before performing any of the procedures outlined in this chapter. Again, use only a Prime BSI Express data cable and Prime BSI Express interface card with the camera. Using a different cable or interface card may result in unexpected errors or permanent damage to the system.

Introduction

The Prime BSI Express camera system includes the following hardware components:

- Prime BSI Express Scientific CMOS Camera
- USB 3.2 Gen 2 Cable
- USB 3.2 Gen 2 Interface Card
- A 12V/ 5A power supply with international power cord set
- Two single-line MMCX trigger cables
- USB memory device containing PVCAM library and drivers
- Quick Installation Guide

Prime BSI Express system components are linked by the USB 3.2 Gen 2 data cable and controlled by the host computer system. All these hardware components should be included with the shipment. Keep all the original packing materials so you can safely ship the camera to another location or return it for service.

If you have any difficulty with any step of the instructions, contact Teledyne Photometrics Customer Service.

Getting to Know Prime BSI Express

Highlights of the Prime BSI Express camera are shown below: The Prime BSI Express package includes the PVCAM drivers designed to allow you to use this camera with a variety of third party imaging software - To see a list of supported software, visit the Teledyne Photometrics website.

Multiple Cooling Options

Forced Air Cooling

- 0°C Cooling
- Selectable Fan Speed

Advanced Application Triggers

Effective Global Shutter

- Up to four selectable signal lines
- Two single-line MMCX trigger cables

Convenient Interfaces

16-bit / 12-bit Data

- 43.5 fps

11-bit Data

- 95 fps

DC IN: Connection to external 12V/ 5A DC power supply



Figure 1

Software Compatibility Requirements

Unless there is a preferred version specified by a third party software provider, the latest version of PVCAM is recommended for use with the Prime BSI Express.

Host Computer Requirements

The host computer (PC) for Prime BSI Express must meet the following minimum requirements:

- Windows 8/10 64-bit operating system
- 2.0 GHz or faster Intel processor: either Xeon or Core i7
- 8+ GB RAM
- 250+ GB serial ATA (SATA) HDD and/or >512 GB solid state drive (SSD) for high-speed imaging and storage
- 512+ MB slot-based ATI/NVIDIA video graphics card (i.e., not an "onboard/integrated graphics" adapter)
- USB port for use with the USB memory device or Internet access to obtain the PVCAM library and interface drivers
- USB 3.2 port for use with the Prime BSI Express USB 3.2 interface
- An open PCI-Express 4x (4 lane) interface slot or higher for use with the USB 3.2 Interface Card if the PC does not have a USB 3.2 Port

Software Installation

An appropriate Installation Guide is included as an insert with the camera. This guide provides step-by-step instructions for installing the camera interface software for Windows-based computers. Additional instructions are included for installing an interface card in the computer

The Teledyne Photometrics USB memory device contains the following files:

- Manuals Directory – contains user manuals in PDF format.
- Customer Case Studies – application examples
- Imaging Software – a copy of Open Imaging's FOSS Application, Micromanager
- Technical Notes – detailed background on advanced features
- For a 64-bit Windows OS, install the PVCam driver.
- Follow the Installation Guide insert for the version of Windows being used. Reboot the computer when the installation is complete.

Installing the USB 3.2 Gen 2 Interface Card

As CMOS cameras have developed, the amount of data generated from these products has exceeded the current capabilities of USB 3.0 interfaces. The Prime BSI Express sCMOS camera relies on the 10 Gbps USB 3.2 Gen 2 interface to keep up with the high speed data transfer required to reliably use the product.

It is important that the PC is restarted after the USB 3.2 Interface card is installed. This will ensure that as the computer goes through the boot process, it discovers the camera.

Install the USB 3.2 Gen 2 Interface Card



Figure 2

Note: The model of interface card shipped with the camera may differ from the one shown in the photo.

Before attempting to operate the camera, first install this interface card into the PC with the following steps:

1. Shut down the PC
2. Unplug the PC from power mains and ensure the camera is turned off

3. Open the side of the computer to access the PCI and PCIe slots



Figure 3

4. Locate an available 4 channel or higher PCIe slot (marked x4). Refer to the PC's documentation to locate a suitable slot.

Tip: The PC may have motherboard slot information on the side cover

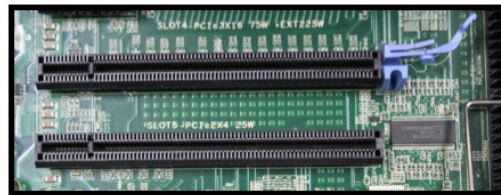

Figure 4

Holding the Prime BSI Express PCIe card and (being careful not to touch the board components or PCIe bridge pins) insert it with the proper orientation into the open slot. The card should slide into place with minimal resistance and snap when fully inserted.

PrimeBS Express' USB3.2 Gen 2 interface is ubiquitous and easy to use. To use the interface, the PC must have an open USB3.2 port or USB 3.2 interface card.

Connecting Prime BSI Express with USB 3.2 Gen 2

It is not recommended to connect to the Prime BSI Express external USB3.0 hubs.



Figure 5

Note that the ends of the USB3.0 cable are different between the camera and PC, and require a specific orientation. The camera has a "Type C" connector and the computer will have a "Type A" connector. Do not force insertion when connecting the cable – if significant resistance is encountered stop, reexamine the connection, and if correct, retry.

With the cable connected on both ends, you are now ready to power on the computer:

1. With the camera off, connect the USB3.2 cable between camera and host computer.
2. Power the camera on.
3. Wait 30 seconds before launching the application. An LED on the rear of the camera will stop blinking when the camera is initialized and ready to communicate.

Chapter 3 – Theory of Operation

Introduction

Backside illuminated scientific CMOS (BSI Scientific CMOS) sensors are a recent development in image sensor technology. BSI CMOS sensors are able to provide the highest levels of sensitivity with a near perfect 95% quantum efficiency (QE). This QE coupled with large pixel CMOS sensors which have high frame rates, high pixel counts, and low electronic noise provide the most complete low-light scientific imaging solution.

CMOS Image Sensor Structure

A major difference between traditional CCD sensors and CMOS sensors is the location where charge-to-voltage conversion of accumulated photoelectrons takes place. CCD sensors transfer the pixels accumulated signal in charge packets in “bucket brigade” fashion across the sensor to a common output node where charge is converted to a voltage. The voltage is then sampled using off-chip Analog-to-Digital Converters (ADC) and transferred to the PC as digital grey values.

While providing excellent quantitative photometry and very high image quality, the large number of transfers and sequential digitization of pixels results in low frame rates. This speed penalty increases with the number of pixels to be digitized.

CMOS sensors leverage many of the same analog signal concepts used in CCDs, but places the output node circuitry inside each pixel. This eliminates the charge transfer process. To read the signal from a given row, the accumulated charge is converted to a voltage inside the pixel, then each pixel in the row is connected to the appropriate column voltage bus, where the on-chip ADCs convert the voltages to an 11-bit or 12-bit grey value. (Thus far, the on-chip ADCs available on CMOS sensors have limited dynamic range.)

The parallel digitization of all pixels in a row provides CMOS devices with a tremendous speed advantage. Imagine a CCD with 2048 x 2048 pixels – and each pixel’s voltage is measured in 1µsec. To read a single row, 2048 voltage measurements are performed in serial fashion taking slightly longer than 2ms, and when repeated for 2048 rows, the entire image takes over 4 seconds to be digitized.

On a CMOS device – the entire 2048 voltage conversions needed to digitize a row happen in parallel.

If the time to digitize a pixel remains at 1μsec – the time to read the entire frame is now 2ms. In practice, the time saving is split between faster frame rates and slowing the rate of pixel measurement to reduce electronic noise. For example, if the time to measure a pixel was increased to 11.2μsec to lower noise, the image sensor can still be read in 23ms (for a maximum 43.5fps).

Of course, there are many challenges to obtaining the same analog performance from each of the Prime BSI Express' 4.2 million pixels, whereas a CCD has a single, common output node resulting in a uniform response. The most common problems are pixel-to-pixel non-uniformity in gain and offset, random telegraph noise (RTN), and defective pixels with abnormal noise or dark current characteristics (hot pixels).

Often solutions to these challenges are found in the digital domain, where Prime BSI Express' advanced real time signal processing corrects each pixel for gain and offset variation using calibration at the factory. To address RTN and other pixel defects, real-time digital filters are used. These corrections are described further in this manual.

Gain Combining and Bit-Depth

As discussed in the previous sections, the column ADCs present in scientific CMOS devices have limited dynamic range. This is addressed by making two measurements of the accumulated charge in each pixel – the first with very high sensitivity but limited to a maximum signal of approximately 1000 electrons, and the second with reduced sensitivity but capable of measuring signals up to the pixel's 45,000 electron full well capacity.

Combining the two measurements into a single 16-bit value is the function of the digital "gain combiner." This mathematical operation is performed on the camera's FPGA. The result is a single gain of approximately 0.6 e-/ADU.

In practice, the Prime BSI Express offers both a combined ADC 16-bit output as well as a 11-bit single ADC output. The combined gain takes two measurements of a pixel for the combined ADC 16-bit output. The 11-bit mode is able to sample 2 rows simultaneously as only a single sample is required resulting in an increase in frame rate.

Since the 11-bit mode does not have the flexibility in dynamic range provided by HDR mode, multiple gain states are provided so that acquisition can be optimized for the required performance. These gain states are:

- *Full Well* - Provides maximum full-well capacity with a gain of ~ 4 e-/ADU
- *Balanced* - Provides the best balance between read noise and full-well capacity with a gain of ~ 2 e-/ADU
- *Sensitivity* - Provides the highest levels of sensitivity with a gain of ~1 e-/ADU

Rolling and Global Shutter Readout

Rolling Shutter and Global Shutter are the two primary operating modes of CMOS image sensors. In Global Shutter readout, a global charge clearing mechanism begins the exposure period for all pixels. Each pixel accumulates signal charge until the exposure period ends. At this point, the accumulated charge is transferred and converted to a voltage in the pixels output node, ending the exposure.

The strength of the Global Shutter approach is that all pixels are exposed at the same instant in time – an important attribute when imaging fast moving objects. The downside of this approach is the sensor has two phases, an active image accumulation phase and a subsequent readout phase. As the phases are not overlapped in time, the maximum achievable frame rate is lower.

In Rolling shutter readout, exposure and readout are overlapped. This is accomplished by beginning the exposure one row at a time, then starting the readout one row at a time (The row being digitized “rolls” through the sensor).

For Prime BSI Express, the time to digitize a single row is $11.2\mu\text{sec}$ in HDR mode. Digitizing 2048 rows of pixels, the time delay from the top to the middle of the sensor is approximately 24ms. Since readout and exposure are overlapped, the sensor achieves the maximum frame rate of 43.5fps. In the 11-bit mode, while two rows are read out simultaneously at a slightly slower rate, the row time is equal to $10.32\mu\text{s}$, providing an increase maximum frame rate of 94.5 fps.

The graphic below depicts the time delay between each row of pixels in a rolling shutter readout mode with a CMOS camera.

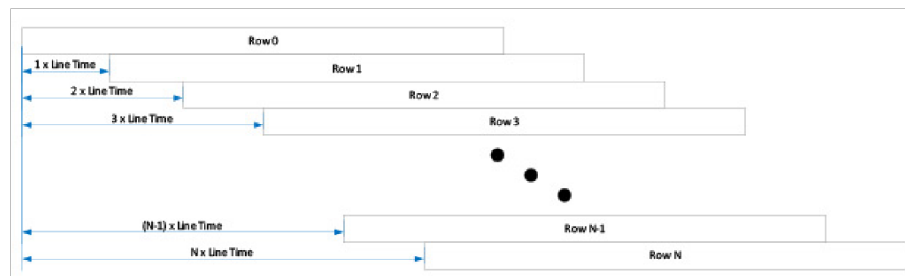

Figure 6: Rolling Shutter Exposure Row by Row Exposure Start/End Offset

The downside of Rolling Shutter readout is that changes in the scene on similar time scales is distorted, as each row samples the image at different times. This is the well known “rubber band” effect – but can appear in fluorescence microscopy as shaded illumination when rapidly changing wavelengths.

To maintain the benefit of Rolling Shutter readout and eliminate rolling shutter artifacts, external illumination can be gated on when all rows are being simultaneously exposed, and off during the readout phase. This external triggering mode used in combination with high speed light sources (lasers, LEDs) achieves a pseudo global shutter effect. This triggering mode is described in the device synchronization section of this manual.

Digital Binning

Highlights of the Prime BSI Express camera are shown below: CCD image sensors are capable of charge binning (combining adjacent pixels into one super pixel). This is accomplished as part of the charge transfer process and has the advantage of increasing signal to noise in read-noise limited situations, at the expense of spatial resolution.

The lack of a charge transfer process in CMOS devices means true charge binning is not available in currently available sCMOS sensors. Even so, co-adding pixels is a convenient means to reduce image data, or increase signal by 4x and improve SNR by 2x as the noise from each pixel adds in quadrature.

Prime BSI Express includes 2x2 on-camera simulated binning, done on the FPGA. This mathematically combines signal from adjacent pixels and adjusts the sum so that the bias offset is only added one time.

Sensor Clearing

In order to capture the highest signal to noise ratio possible, it is important that scientific cameras minimize any signal that's not derived from the sample. One contribution to this background signal is the buildup of charge prior to an exposure, which includes any light still reaching the sensor and thermally generated sensor dark current. To eliminate this pre-acquisition charge accumulation, most CCD and CMOS cameras clear the sensor one or more times prior to exposing the sensor to light. This can be done using a "fast" readout that is subsequently discarded.

Unlike CCDs, there is limited benefit to performing multiple pre-exposure clearing cycles with CMOS, because each pixel is reset as part of the normal readout process, and the charge transfer registers that can hold residual signals are not present.

Bias Offset

Scientific cameras produce a fixed artificial signal offset known as bias offset. This offset is present even when no light is falling on the sensor and the exposure time is set to zero. This preserves quantitation even down to signals of a few electrons per pixel. Typically, the user subtracts this offset before performing quantitative analysis post-acquisition.

The recommended protocol is to capture a new series of bias frames at the start of each experimental run. The series of frames can be averaged to remove noise, then used to remove the bias offset during subsequent image analysis. This can also be used to monitor for light leaks and other systematic effects that can impact experimental results.

Pixel Noise Filters

Note: The Prime BSI Express camera ships with an optimized default setting for Real Time Pixel Noise Filtering. Normally these values do not need to be adjusted. Additionally, the features described in this section may not be controllable in the software application. This is an advanced usage section.

In the CMOS sensor section, it was noted that a drawback to current CMOS sensors is variability in pixel to pixel response. This variability falls into two categories, static variation in gain and offset and dynamic fluctuations that require real-time Pixel Noise Filters, also known as “Despeckling”.

The static variation in gain and offset is measured and a correction factor is determined for every pixel. This fixed pattern noise is measured during manufacture and the corrections are stored in the camera. These corrections are then applied in real-time to each image.

The dynamic fluctuations must be detected and corrected in real-time. Prime BSI Express has several noise filters for this purpose. Defect detection is based on use of a conditional median filter. The 3x3 neighborhood surrounding a pixel is examined. If the pixel’s value exceeds or falls below the median by a given amount, its value is replaced by the median.

Four filters are available:

Real-time Filters for Random Telegraph Noise:

1. Despeckle Dark Low
2. Despeckle Bright Low

Real-time Filters for Bright (Hot) or Dark Pixels:

3. Despeckle Dark High
4. Despeckle Bright High

“Dark” filters work on the low side of the local median, while “Bright” filters work on the high side of the local median. The filter is only applied if the pixel’s value exceeds (or is below) a threshold expressed as a percent of the local median x 100.

For example, a *Despeckle Dark Low* threshold of “97” indicates that a pixel that is 3% below the local median will be replaced with the local median. A *Despeckle Bright High* threshold of “300” indicates that a pixel that is 200% brighter than the local median will be replaced.

The intensity range where each filter operates can be set by a value known as “Minimum ADU AFFECTED”. Take the “Dark” filters for example – pixel values that fall below the Minimum ADU Affected will be operated on using *Despeckle Dark Low*, and pixel values that lie above the Minimum ADU Affected will be operated on using *Despeckle Dark High* settings.

Given the new terminology – a simplified way to visualize the region in which each filter operates is shown below:

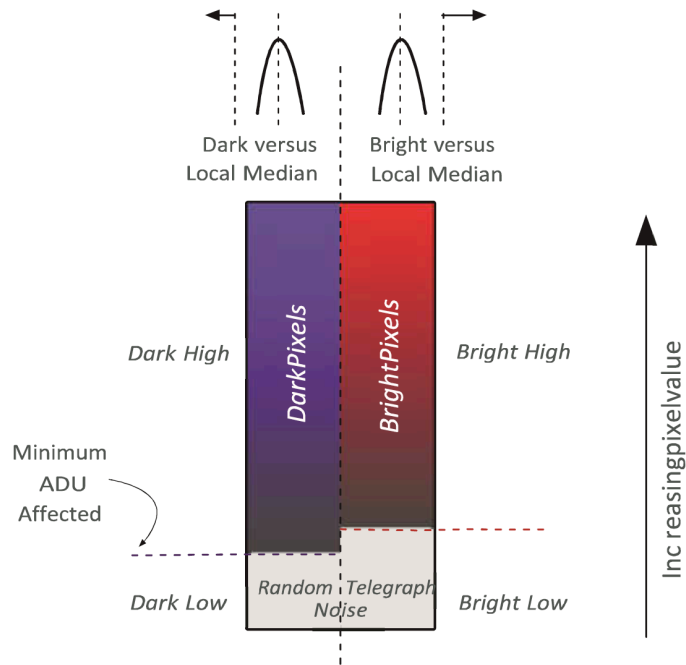

Figure 7: Pixel Noise Filter

The general principle for setting the pixel noise filters is to use as little filtering as possible. Often the best way to determine this is viewing a real-time histogram with log scaling of the frequency. For setting "Dark Low" and "Bright Low", block any light from reaching the sensor and examine the bias histogram. This allows viewing the histogram's tail, where the effect of the filters can be seen. Adjust the filters to trim the non-Gaussian tails from the distribution.

For "Dark High" and "Bright High", observe the image with flat, even illumination in the expected range to be observed. Adjust "Bright High" to eliminate most of the bright speckles and adjust "Dark High" to eliminate any dark speckles that might appear.

Although they can be set independently, it is recommended to keep the Minimum ADU Affected the same for the dark filters and bright filters. This value should be set approximately 1.5X the bias level to ensure the Low filters are operating on RTN noise.

Signal Processing

Prime BSI Express' special capabilities go well beyond the sensor. Its state of the art algorithms combined with copious high-speed DDR3 memory and high speed FPGA's (Field Programmable Gate Arrays) provide new opportunities for extracting the best information from acquired images. Teledyne Photometrics leveraged the revolution in computational imaging with new features.

Chapter 4 – Operating Features

Introduction

This section explains Prime BSI Express' different modes of operation and the best modes to optimize imaging performance.

Gain States

Prime BSI Express has three modes

1. HDR Combined Gain 16-bit output
2. Correlated Multi-Sampling (CMS) 12-bit output
3. Single Gain 11-bit output

The HDR Combined Gain 16-bit mode provides the best balance between full-well capacity and noise performance. However, it provides lower frame rates than the single gain outputs.

The CMS mode provides the lowest read noise performance, achieving approximately $1e^-$ of read noise. The signal is sampled twice by configuring both the amplifiers to have high sensitivity. CMS modes trades off dynamic range for lower read noise. It has the same frame rate as the 16-bit HDR mode.

The 11-bit mode provides the highest frame rates. To provide imaging flexibility, 3 gain states are provided in this mode:

- Full Well - Provides maximum full-well capacity with a gain conversion factor of $\sim 4e^-/ADU$
- Balanced - Provides the best balance between read noise and full-well capacity with a gain conversion factor of $\sim 2e^-/ADU$
- Sensitivity - Provides the highest levels of sensitivity with a gain conversion factor of $\sim 1e^-/ADU$

Bias Offset Setting

The factory default bias level is approximately 100 ADU. If supported by the software application being used, the bias level can be changed. It is recommended that this value not be changed as the preset values for the defective pixel noise filters are set with this value.

Clearing Mode Selection

Prime BSI Express' provides a single clear mode – “Clear Auto”. Prime BSI Express is continuously clearing the sensor while there are no images being acquired. This eliminates unnecessary sensor clearing and maximizes frame rates.

The following waveforms show how the overlap behavior of “Clear Auto” functions for the Prime BSI Express camera.

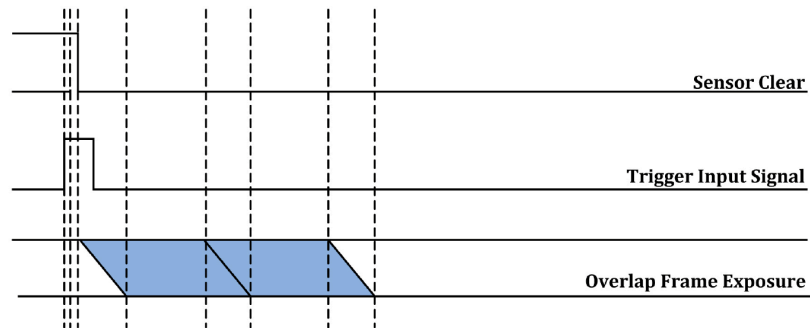

Figure 8

Single Regions Of Interest

Regions of Interest (ROIs) are image sub regions selected by the user to be captured and delivered to the host PC in place of the full image. This can substantially increase frame rates and lower the amount of data that needs to be processed.

Frame rates increase with decreasing numbers of rows contained in the ROI. By reducing the number of rows, frame rates above 1000fps are achievable with small ROIs. As a result, the sensor architecture, if any pixel in a row is part of the ROI, the entire row is digitized. Reducing the number of columns in the ROI does not improve the frame rate of the camera, but it does reduce the amount of data acquired, saving computer resources and processing time.

Programmable Scan Mode

Programmable Scan Mode provides increased control over the rolling shutter exposure and read-out functionality of CMOS sensors. The rolling shutter read-out behavior is a common implementation on CMOS sensors, and Programmable Scan Mode provides access to the sensor timing settings to allow optimization around imaging requirements.

Programmable Scan Mode provides access to three modes:

- Auto

When Programmable Scan Mode is set to Auto, the line-time is set to 1 line. This provides the highest framerates and minimal control over the ability to set the width between the reset and readout signals. There is no delay added after the line time. This is the default option for the Scan Mode.

- Line Delay

When Programmable Scan Mode is set to Line Delay, a delay can be added after the line-time, slowing the propagation of the reset and readout signals. This causes the effective line time of the sensor to be increased. This delay is added onto the default line time in increments equal to the line-time.

$$\text{Line Time}_{\text{Effective}} = \text{Line Time}_{\text{Sensor}} + (\text{Line Time}_{\text{Sensor}} \times \text{Line Delay Value})$$

A value of 1 adds a delay equal to 1 line-time. This results in an effective line-time equal to double the value of line time.

$$\text{Line Time}_{\text{Sensor}} = 10\mu\text{s}$$

$$\text{Line Delay Value} = 1$$

$$\text{Delay} = 10\mu\text{s} \times 1 = 10\mu\text{s}$$

$$\text{Line Time}_{\text{Effectiveness}} = 10\mu\text{s} + 10\mu\text{s} = 20\mu\text{s}$$

A value of 10 adds a delay of 10 line-times which results in an effective line-time equal to 11 times longer than the default line-time.

$$\text{Line Time}_{\text{Sensor}} = 10\mu\text{s}$$

$$\text{Line Delay Value} = 10$$

$$\text{Delay} = 10\mu\text{s} \times 10 = 100\mu\text{s}$$

$$\text{Line Time}_{\text{Effectiveness}} = 100\mu\text{s} + 10\mu\text{s}$$

The frame rate when imaging in this mode is determined by the number of rows being imaged and the Effective Line Time.

$$\text{Readout Time}_{\text{Image}} = \text{Line Time}_{\text{Effective}} \times N_{\text{Rows}}$$

$$\text{Frame Rate} = \frac{1}{\text{Readout Time}_{\text{Image}}}$$

A Scan Width parameter is available and reports the number of rows between the reset and readout signals.

- Scan Width

When Programmable Scan Mode is set to Scan Width, the number of rows between the reset and readout signal can be set. It gives direct control to set the size of the imaging region.

Scan Width = Number of Rows between Reset and Readout

When the Scan Width is set, the effective line time required is automatically calculated.

$$\text{Line Time}_{\text{Effective}} = \frac{\text{Exposure Time}}{\text{Scan Width}}$$

Device Synchronization (Triggering)

A Scan Line Time parameter is available and reports the Effective Line Time in nanoseconds Programmable Scan Mode also provides control over the direction of the scan. The available options are:

The Prime BSI Express offers several methods of integrating with external hardware devices. Each camera has four MMCX connectors on the back of the camera for trigger input/output operations. The signals provided to the user are:

Trigger In (TRIG IN)	Inputs initiate an exposure or sequence
Trigger Ready Out (TRIG RDY)	Status indicating if the camera can accept another trigger
Read Out (RD OUT)	Status indicating the camera is currently digitizing
Expose Out (EXP OUT)	Output for controlling illumination source 1

Single-line microminiature co-ax (MMCX) cables are included with the camera to access these functions. Each signal requires a cable that can be read with an oscilloscope or signal analyzer

Trigger Modes

Prime BSI Express supports four trigger modes and expose out behaviors. The triggering modes and expose out behaviors of the camera are described as:

Timed Mode (Internal)

Timed mode is the default triggering mode for Prime BSI Express. This means, the software/ application initiates the start of a sequence of acquisitions. Once initiated, each frame captured in the sequence is controlled by the internal timing generators of the camera. Camera settings, expose out behavior and sequence size are set in the software application prior to acquiring the sequence. Timed mode is used when synchronization with other devices is either not required or is controlled independently through the software.

Trigger-First Mode

Similar to Timed Mode but requires a hardware trigger from the I/O connector. Hardware triggers enable a higher precision of acquisition timing than software triggers. Rising edge of an external trigger initiates the start of a sequence of acquisitions. Once initiated, each frame capture in the sequence is controlled by the internal timing generators of the camera. Camera settings, expose out behavior and sequence size is set in the software application prior to acquiring the sequence.

Edge Mode

Similar to Timed Mode but requires a hardware trigger from the I/O connector. Hardware triggers enable a higher precision of acquisition timing than software triggers. Rising edge of an external trigger initiates the start of a sequence of acquisitions. Once initiated, each frame capture in the sequence is controlled by the internal timing generators of the camera. Camera settings, expose out behavior and sequence size is set in the software application prior to acquiring the sequence.

Expose Out Modes

The settable Expose out behaviors provide flexibility in different experimental scenarios. Note: All timing diagrams below are shown with *Edge triggering mode*.

First Row

The “Expose Out” signal leaving the camera is high only when the first row of a single frame is being exposed. The length of the signal is equal to the exposure time for the first row. Exposure time is equal to what is set in the software application. Although “First Row” behavior provides the maximum camera frame rates, it does not avoid the overlap due to rolling shutter. This mode is not recommended if trying to alternate between excitation wavelengths.

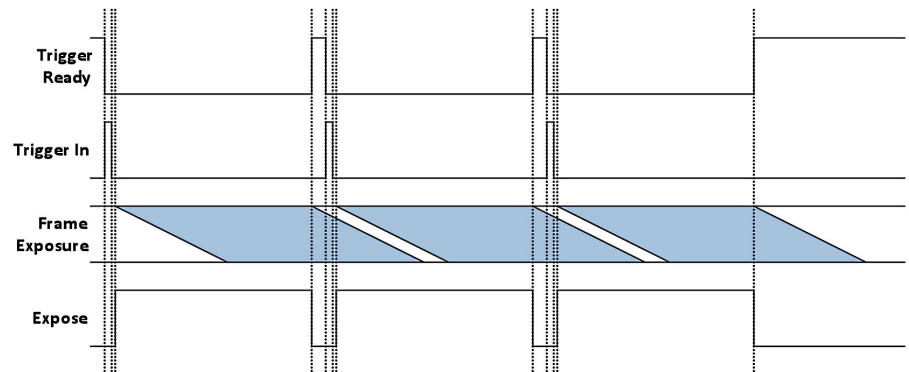

Figure 10

Any Row

The “Expose Out” I/O signal leaving the camera is high when any row in a single frame is exposing. The length of the Expose Out signal is equal to the time between the start of the first row’s exposure and the end of the last row’s exposure. Each line exposes for the same amount of time which is equal to what is set in the software application. Maximum camera frame rates are not possible in this mode but this does avoid frame overlap.

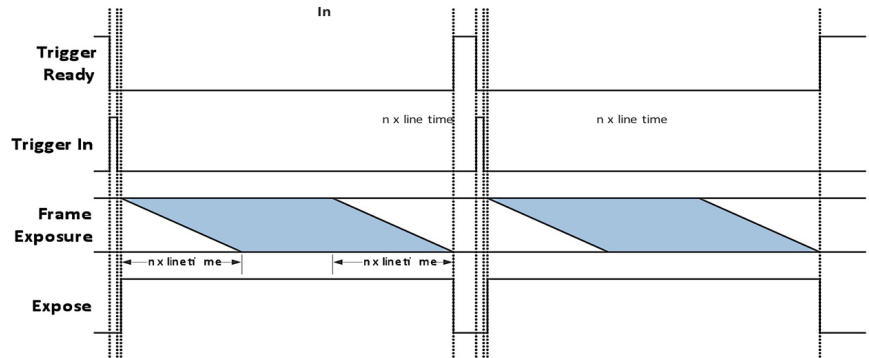

Figure 11

Rolling Shutter Mode

The Rolling Shutter Expose Out Mode is similar to First Row Mode, except that the Expose Out signal is high only when all rows are exposing.

When Exposure time is less than readout time:

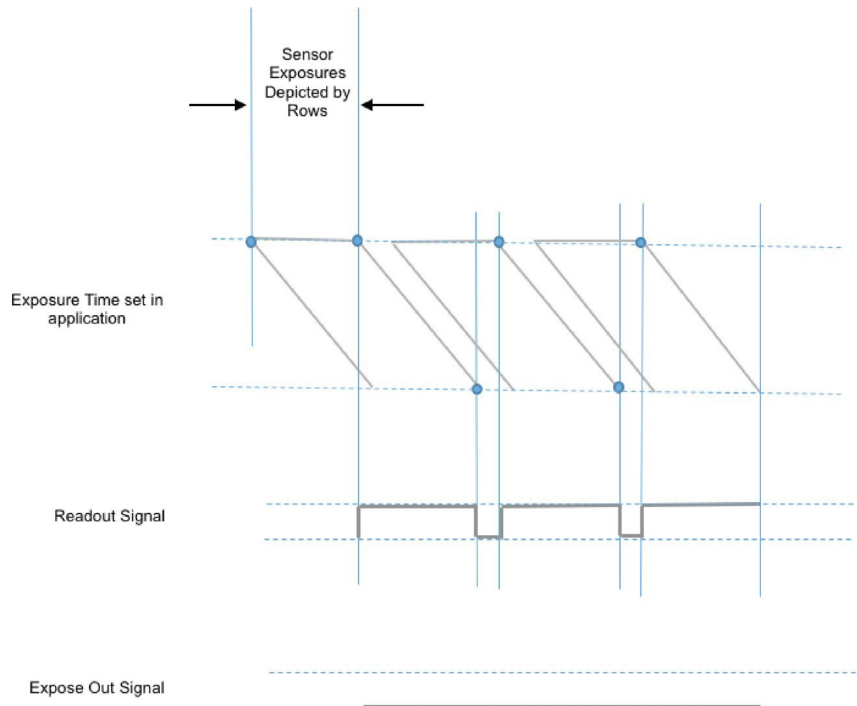

Figure 11

When Exposure time is more than readout time:

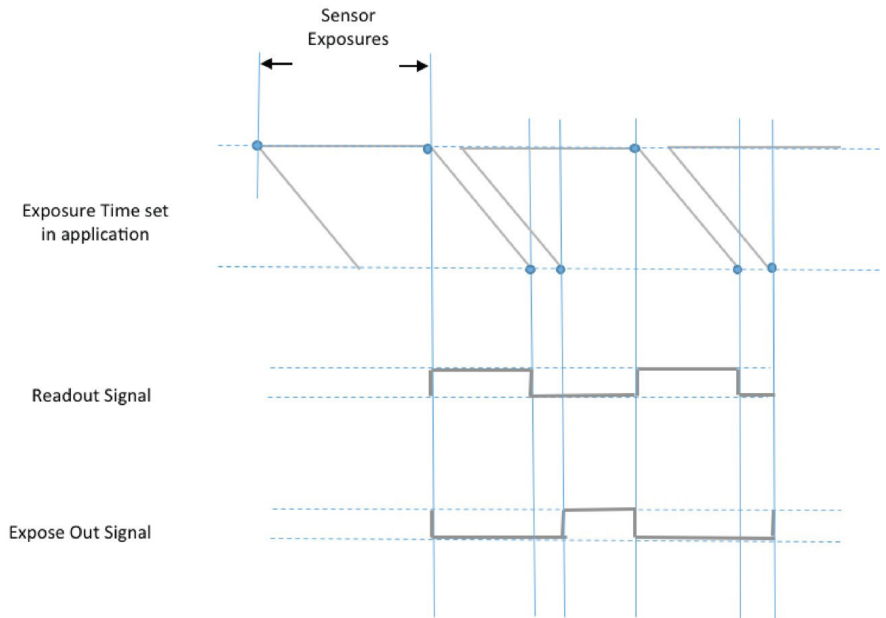

Figure 12

SMART Streaming

Sequenced Multiple Acquisition Real Time Streaming, aka SMART Streaming, is an exclusive Photometrics camera feature that enables Prime BSI Express to capture a continuous sequence of images, while cycling through a maximum of 16 pre-programmed exposure time values. This avoids the overhead of host communication time, resulting in very high frame rate imaging while maintaining the correct exposure level for each fluorophore.

The maximum exposure time per frame is 10 seconds in keeping with the SMART Streaming high frame rate benefits.

When Multiple Output Triggers is combined with SMART streaming, it is possible to control the exposure time of each output independently. This is much faster than using software-based methods for control timing of illumination devices.

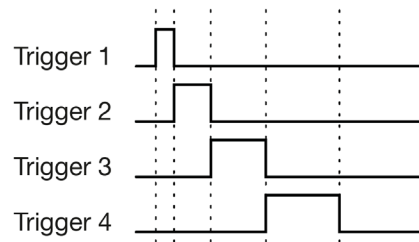

Figure 13

Fan Speed Control

Fans are often used to remove heat from the camera due to their convenience. However, under demanding conditions, fan vibration isolation is insufficient for single molecule localization, high magnification imaging or use with micromanipulators.

Prime BSI Express solves this problem in two ways. First, a new, innovate fan mounting system was developed that isolates fan vibration from the rest of the camera. Side by side testing with competing products indicated that Prime BSI Express outperforms alternatives in terms of vibration isolation.

Secondly, the fan has variable speed control. The lower the fan speed, the lower the vibration transferred. Prime BSI Express provides three fan speeds, and even on the lowest setting, it can still reach nominal -15°C sensor cooling in a 23°C ambient.

speed settings include:

1. High
2. Medium
3. Low

Time Stamps

Prime BSI Express is able to output "metadata" that describes data associated with each frame. Metadata contains useful information like the exposure time, ROI location and time stamps. Metadata is inserted directly into the frame buffer and transferred together with the image data.

Time stamps are particularly useful. Prime BSI Express generates Driver Generated Timestamps (for legacy support) in the host PC and Hardware Timestamps generated in the camera. The accuracy of Prime BSI Express' Hardware Timestamps is approximately 20 μ sec, one row read time from the sensor. This is far better than the 1 ms accuracy of Driver Generated Timestamps. Hardware Timestamps are given in units of 1 ns.

To display Hardware Timestamps in the Micro-Manager application, metadata must be enabled for Prime BSI Express in the Device Property Browser. When acquiring a sequence, Hardware Timestamps will be displayed in the metadata tab with the prefix "FMD" (for Frame metadata).

Note: Prime BSI Express has timestamps for "Bof" for "Begin of Frame" and "Eof" for "End of Frame" events, which differ by approximately 10 ms, which was the preset exposure time.

NAME	VALUE
PVCAM-FMD-ExposureTimeNs	9993600
PVCAM-FMD-FrameNr	11
PVCAM-FMD-TimestampBofNs	254157974400
PVCAM-FMD-TimestampEofNs	254167804800

Figure 14

Chapter 5 – Troubleshooting

Note: For difficulty in troubleshooting or if the symptoms are not listed here, contact Teledyne Photometrics Customer Service.

System Does Not Boot Normally

If the operating system does not boot normally after the interface card is installed, try reseating the PCIe card. If this is unsuccessful, try installing the new card in another open PCIe 4x or higher slot. If this does not work:

1. Turn off the computer and remove the newly installed interface card.
2. Turn the computer on. If the system boots normally, there is probably an interrupt conflict between a previously installed device

If you need assistance resolving the interrupt conflict, contact Teledyne Photometrics Customer Service.

New Hardware Found Dialog Box Does Not Appear

If the New Hardware Found dialog box does not appear after installing a new interface card:

1. Make sure the new interface card is inserted in an expansion slot according to the computer manufacturer's instructions
2. Ensure Prime BSI Express is connected and powered on at least 10 seconds before starting the computer when using the PCIe interface.
3. When using the USB3.0 interface, wait for the LED on the rear of the camera to stop blinking before checking for "New Hardware Found" and the application.

It is possible that due to the power states settings of your computer, the PCI-Express card was not properly detected. Following this boot up procedure to see if the camera is detected, when using the PCI-Express interface:

1. Turn on Camera
2. Wait for LED to stop blinking
3. Turn on Computer
4. When computer has booted, power cycle the camera
5. When the LED stops blinking, restart computer

If the New Hardware Found dialog box still does not appear, contact Teledyne Photometrics Customer Service.

Images Not Displayed

If no images appear:

1. Confirm the camera switch is set to on.
2. Confirm that the Prime BSI Express camera is selected in the imaging software application.
3. Power off the camera and the host computer and check all system connections (particularly the DATA and power cables), then restart.
4. Confirm the camera is operational by taking an image with a standard C-mount lens attached to the camera. Using normal room lighting, place the camera on a table about three meters away from an object and acquire an image.

If the problem persists, contact Teledyne Photometrics Customer Service.

Camera Running Too Warm

It is normal for the camera to be slightly warm to the touch while in operation. However, if it is more than slightly warm to the touch (and at least one inch of space has been left around the external cooling fins for airflow), switch off the camera immediately and contact Teledyne Photometrics Customer Service.

PVCAM Error Message Appears

If a PVCAM error message appears, note the message's number code and contact Teledyne Photometrics Customer Service

Lengthy Pauses During Imaging

If you notice lengthy pauses marked by a lot of disk activity while imaging:

- Close any other programs that may be running.
- Install more physical memory (RAM) in your computer system.

Chapter 6 – Basic Specifications

Prime BSI Express: Front, Side And Rear Views

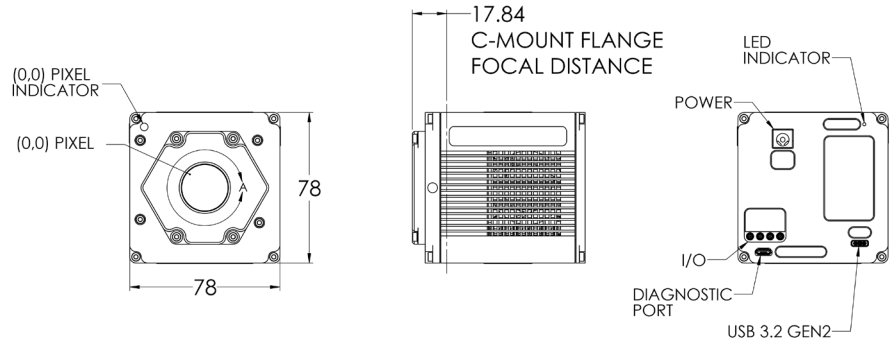

Figure 15

Camera Weight

Weight: 3.8 lbs. (1.7 kg)

Sensor Specifications

Window	UV grade fused-silica Broadband MgF2 anti-reflective coating on both surfaces
BSI Scientific CMOS Sensor Array	
Sensor	Gpixel GSENSE2020BSI Scientific CMOS sensor
Sensor Process	Backside illuminated scientific CMOS
Resolution	2048 x 2048
Pixel Size	6.5µm x 6.5µm

Power Supply Specifications

Voltage Input:	100-240 V~ @ 50-60 Hz
Current Input:	5 A (110V nominal)
Voltage Output:	+12V @ 8 A
Maximum Power Output:	140 W
Supply Cable Length:	4 ft. / 1.22 m
Certifications:	CE, UL, CUL, FCC, PSE Efficiency level VI

Note: CE certification applies to the Prime BSI Express camera only when the camera system operates with a CE-approved power supply



www.photometrics.com

Main Phone: +1 520.889.9933

Support: +1 604.530.5800 / +1 800.874.9789